



MAX5387 Evaluation System

General Description

The MAX5387 evaluation kit (EV kit) is an assembled and tested PCB that features the MAX5387L 10k Ω dual digital potentiometer. The MAX5387 EV kit is populated with two MAX5387L ICs and communicates through an I²C-compatible serial interface (or through a stand-alone 2-wire serial interface).

The MAX5387EVMINIQU+ evaluation system (EV system) includes the EV kit and the MINIQU⁺ interface board. The MINIQU⁺ interface board can be used to enable PC communication through the 2-wire serial interface. Windows[®] 2000-, Windows XP[®]-, and Windows Vista[®]-compatible software provides a professional user interface for exercising the MAX5387's features. The program is menu-driven and offers a graphical user interface (GUI) complete with buttons, track bars, and edit boxes. The EV kit software can also be used to evaluate the MAX5392. The EV kit can also be interfaced directly to a user-supplied 2-wire system.

The MAX5387 IC can be powered from a 2.6V, 3.3V, or 5V source generated from the MINIQU⁺ interface board and EV kit circuitry, or from a user-supplied external 2.6V to 5.25V DC power supply. Order the MAX5387EVMINIQU+ for a complete PC-based evaluation of the MAX5387.

The EV kit can also be used to evaluate the MAX5387M and MAX5387N. The EV kit contains PCB footprints for two MAX5392 ICs, which allows the user to independently control up to eight potentiometers. To evaluate the MAX5392, order samples and fit the parts in places U3 and U4.

Windows, Windows XP, and Windows Vista are registered trademarks of Microsoft Corp.

Features

- ◆ 2.6V to 5.25V Single-Supply Operation
- ◆ Controls Up to Eight Potentiometers
- ◆ I²C-Compatible Serial Interface or Stand-Alone 2-Wire Serial-Interface Operation
- ◆ Easy-to-Use Menu-Driven Software
- ◆ Includes Windows 2000-, Windows XP-, and Windows Vista-Compatible Software
- ◆ Fully Assembled and Tested

Ordering Information

PART	TYPE
MAX5387EVMINIQU+	EV System

+Denotes lead(Pb)-free and RoHS compliant.

Component Lists

MAX5387 EV System (MAX5387EVMINIQU+)

PART	QTY	DESCRIPTION
MAX5387EVKIT+	1	EV kit
MINIQU ⁺	1	Maxim command module

MAX5387 EV Kit (MAX5387EVKIT+)

DESIGNATION	QTY	DESCRIPTION
C1, C2, C3, C5, C7, C11, C13, C17-C20	11	1 μ F \pm 10%, 16V X5R ceramic capacitors (0603) TDK C1608X5R1C105K Murata GRM188R61C105K
C4, C8, C9, C12, C14, C15	6	0.1 μ F \pm 10%, 50V X7R ceramic capacitors (0603) TDK C1608X7R1H104K Murata GRM188R71H104K
C6	1	10 μ F \pm 10%, 6.3V X5R ceramic capacitor (0805) TDK C2012X5R0J106K Murata GRM21BR60J106K
C10, C16, C21, C22	0	Not installed, capacitors (0603)



MAX5387 Evaluation System

Component Lists (continued)

MAX5387 EV Kit (MAX5387EVKIT+) (continued)

DESIGNATION	QTY	DESCRIPTION
J1	1	2 x 3-pin header
J2	1	2 x 8-pin header
J3	1	8-pin female receptacle
JU1	1	4-pin header
JU2–JU6, JU11–JU14, JU18–JU21, JU23–JU26	17	2-pin headers
JU7–JU10, JU15, JU16, JU17, JU22	8	3-pin headers
R1	1	40.2k Ω \pm 1% resistor (0603)
R2, R11, R12	3	100k Ω \pm 1% resistors (0603)
R3, R4, R5, R8	0	Not installed, resistors (0603)
R6, R9	2	0 Ω \pm 5% resistors (0603)
R7, R10	2	4.7k Ω \pm 1% resistors (0603)

DESIGNATION	QTY	DESCRIPTION
U1, U2	2	Dual 10k Ω potentiometers (14 TSSOP) Maxim MAX5387LAUD+
U3, U4	0	Not installed, digital potentiometers (16 TSSOP)
U5	1	Adjustable output LDO regulator (5 SC70) Maxim MAX8512EXK+ (Top Mark: ADW)
U6	1	2.6V LDO regulator (5 SC70) Maxim MAX8511EXK26+ (Top Mark: AEG)
U7, U8	1	Logic-level translators (10 μ MAX [®]) Maxim MAX1840EUB+
—	26	Shunts (JU1–JU26)
—	1	PCB: MAX5387/MAX5392 EVALUATION KIT+

Component Suppliers

SUPPLIER	PHONE	WEBSITE
Murata Electronics North America, Inc.	770-436-1300	www.murata-northamerica.com
TDK Corp.	847-803-6100	www.component.tdk.com

Note: Indicate that you are using the MAX5387 or MAX5392 when contacting these component suppliers.

MAX5387 EV Kit Files

FILE	DESCRIPTION
INSTALL.EXE	Installs the EV kit files on the computer
MAX5387.EXE	Application program
FTD2XX.INF	USB driver file
UNINST.INI	Uninstalls the EV kit software
USB_Driver_Help.PDF	USB driver installation help file

μ MAX is a registered trademark of Maxim Integrated Products, Inc.

MAX5387 Evaluation System

Quick Start

Required Equipment

- MAX5387 EV system
 - MAX5387 EV kit
 - MINIUSB+ command module (USB cable included)
- User-supplied Windows 2000, Windows XP, or Windows Vista PC with a spare USB port
- Up to four multimeters

Note: In the following sections, software-related items are identified by bolding. Text in **bold** refers to items directly from the EV kit software. Text in **bold and underlined** refers to items from the Windows operating system.

Procedure

The MAX5387 EV kit is fully assembled and tested. Follow the steps below to verify board operation:

- 1) Visit www.maxim-ic.com/evkitsoftware to download the latest version of the EV kit software, 5387Rxx.ZIP. Save the EV kit software to a temporary folder and uncompress the ZIP file.
- 2) Install the EV kit software on the computer by running the INSTALL.EXE program inside the temporary folder. The program files are copied and icons are created in the Windows **Start | Programs** menu.
- 3) Verify that shunts are configured in the EV kit default state (see Table 1) for proper startup operation of the EV kit software.
- 4) Connect the multimeters to measure voltage across the MAX5387's (U1, U2) WA and LA PCB pads and WB and LB PCB pads.
- 5) Connect the MINIUSB+ interface board to the EV kit J2 and J3 connectors.
- 6) Connect the included USB cable from the PC to the MINIUSB+ interface board. A **Building Driver Database** window pops up in addition to a **New Hardware Found** message when installing the USB driver for the first time. If a window similar to the one described above is not seen after 30s, remove the USB cable from the board and reconnect it. Administrator privileges are required to install the USB device driver on Windows 2000, Windows XP, and Windows Vista.
- 7) Follow the directions of the **Add New Hardware Wizard** to install the USB device driver. Choose the **Search for the best driver for your device** option. Specify the location of the device driver to be **C:\Program Files\MAX5387** (default installation directory) using the **Browse** button. During device driver installation, Windows may show a warning message indicating that the device driver Maxim uses does not contain a digital signature. This is not an error condition and it is safe to proceed with installation. Refer to the USB_Driver_Help.PDF document included with the software if you have problems during this step.
- 8) Start the MAX5387 EV kit software by opening its icon in the **Start | Programs** menu.
- 9) Observe as the program automatically detects the USB connection and starts the main program.
- 10) The main program appears with tab sheet **U1_MAX5387** active.
- 11) Press the **Default** button located on the tab sheet.
- 12) Click on the **U2_MAX5387** tab and then press the **Default** button on the tab sheet.
- 13) Click on the **U1_MAX5387** tab.
- 14) The EV kit software main window appears, as shown in Figure 1.
- 15) The MAX5387 EV kit is now ready for additional testing.

MAX5387 Evaluation System

Table 1. Jumper Configuration

JUMPER	SHUNT POSITION	EV KIT FUNCTION
JU1	1-2	VPOWER = 5V
	1-3*	VPOWER = 3.3V
	1-4	VPOWER = 2.6V
JU2	Not installed*	1.7V LDO disabled
	Installed	1.7V LDO enabled
JU3	Not installed	MAX5387 HA disconnected from the U1 VDD voltage source
	Installed*	MAX5387 HA connected to the U1 VDD voltage source
JU4	Not installed	MAX5387 LA disconnected from GND
	Installed*	MAX5387 LA connected to GND
JU5	Not installed	MAX5387 HB disconnected from the U1 VDD voltage source
	Installed*	MAX5387 HB connected to the U1 VDD voltage source
JU6	Not installed	MAX5387 LB disconnected from GND
	Installed*	MAX5387 LB connected to GND
JU7	2-3*	U1 device address = 0x50 (see Table 4)
JU8	2-3*	
JU9	2-3*	
JU18	Not installed	MAX5387 HA disconnected from the U2 VDD voltage source
	Installed*	MAX5387 HA connected to the U2 VDD voltage source
JU19	Not installed	MAX5387 LA disconnected from GND
	Installed*	MAX5387 LA connected to GND
JU20	Not installed	MAX5387 HB disconnected from the U2 VDD voltage source
	Installed*	MAX5387 HB connected to the U2 VDD voltage source
JU21	Not installed	MAX5387 LB disconnected from GND
	Installed*	MAX5387 LB connected to GND

*Default position.

Detailed Description of Software

Graphical User Interface (GUI) Panel

The MAX5387 EV kit software GUI shown in Figure 1 is a Windows program that provides a convenient means to control two MAX5387 dual potentiometers. Use the mouse or press the Tab key to navigate through the GUI controls. The correct SMBus™/I²C write operations are generated to update the MAX5387 internal memory registers when any of these controls are executed.

The EV kit software features window tabs to select and control two MAX5387 (**U1_MAX5387**, **U2_MAX5387**) dual on-board digital potentiometers and two unpopulated MAX5392 (**U3_MAX5392**, **U4_MAX5392**) digital potentiometers. Status indicators (**Status1** and **Devices Found**) are available to indicate that the EV kit is operational and to display the total number of valid MAX5387 and MAX5392 devices populated on the EV kit. The

SMBus is a trademark of Intel Corp.

DEVICES group box indicates components U1–U4 current ID address and the last write operation **Command Sent** and **Data Sent** indicators.

Additional software features can be evaluated by using the pulldown menu bar. The software has a demo mode that is available by selecting the **Options | Demo Mode** menu item. When in demo mode, all software communication to the EV kit hardware is disabled and most of the software's GUI is functional. This feature enables a user to evaluate the software without hardware connectivity.

By default, the EV kit software configures the MINIUSB+ interface board's 2-wire communication speed to 400kHz. The speed can be reduced to 100kHz, if required, by selecting the **Options | 2-Wire Speed | 100kHz** menu item. This configuration could be required if slower 2-wire devices are connected to the EV kit's SCL and SDA J1 header.

MAX5387 Evaluation System

Evaluates: MAX5387/MAX5392

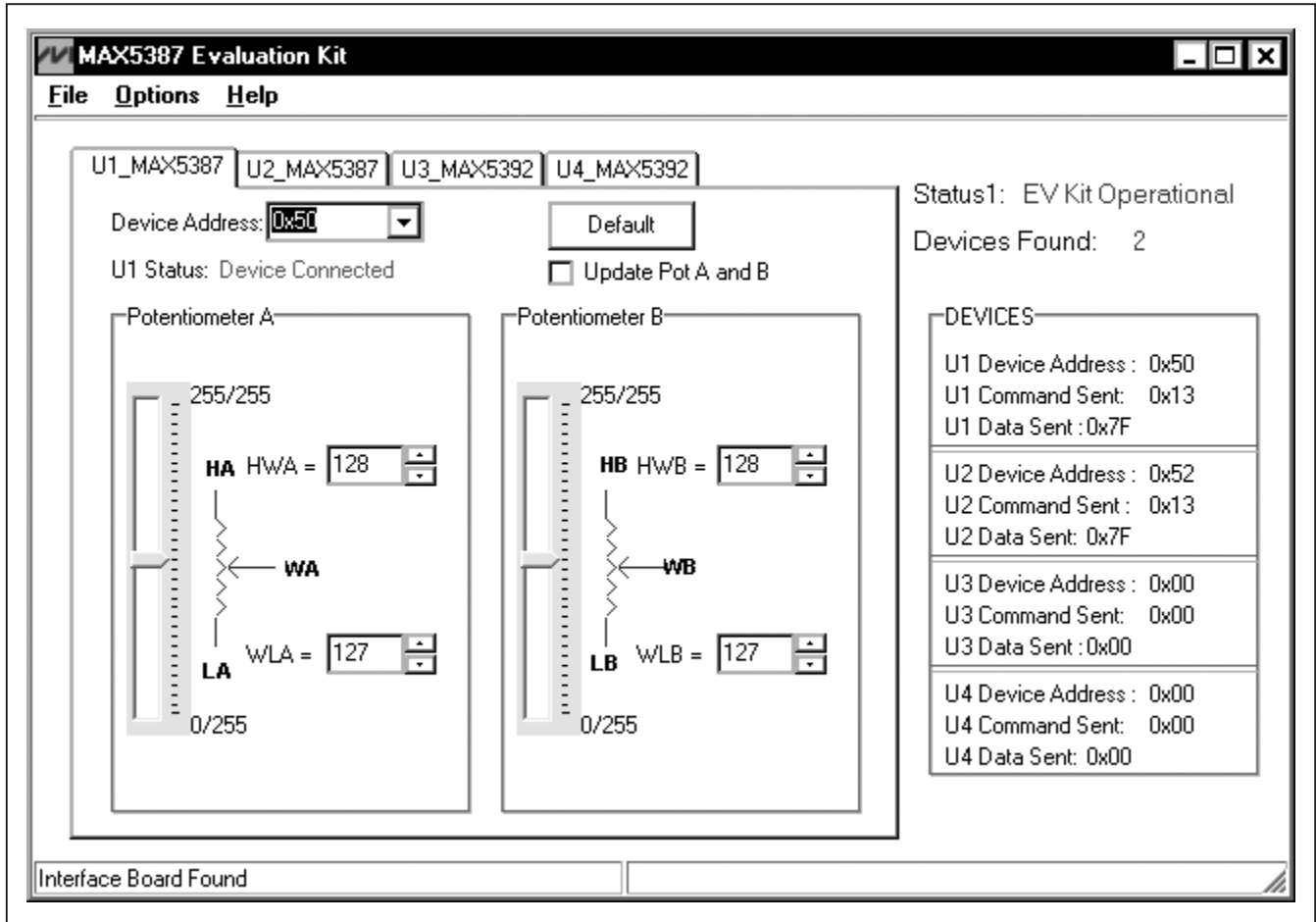

Figure 1. MAX5387 Evaluation Kit Software Main Window

Software Startup

Upon startup, the EV kit software automatically searches for the USB interface board's circuit connection. The EV kit software automatically detects the U1 set 0x50 ID address and the U2 fixed 0x52 ID address and places each address in the **U1_MAX5387** and **U2_MAX5387 Device Address** combo boxes, respectively. Upon detecting the U2 fixed 0x52 address, the **U2_MAX5387 Device Address** combo box is disabled. The EV kit software continuously polls to find valid addresses. The **U2_MAX5387 Device Address** combo box is enabled if address 0x52 is not detected. If U3 and U4 are populated, the user can then navigate to the **U3_MAX5392** and **U4_MAX5392** tab sheets and choose the ID address according to jumpers JU15, JU16, and JU17 shunt positions and the U4 fixed 0x5A ID address.

Demo Mode

The EV kit software enters the demo mode—when the USB connection is not detected, or when no valid MAX5387 ID addresses are found—by selecting **Cancel** on the **MAX5387 Evaluation Kit** pop-up windows (Figures 2 and 3). The software can also enter demo mode at any time from the main window by selecting the **Options | Demo Mode** menu item. Demo mode allows the user to evaluate the software without hardware connectivity. To exit demo mode, deselect the **Options | Demo Mode** menu item.

Potentiometer Tab Sheet Controls

The tab sheets for **U1_MAX5387** and **U2_MAX5387** are used for controlling two MAX5387 ICs. The tab sheets for **U3_MAX5392** and **U4_MAX5392** are used for controlling two unpopulated MAX5392 ICs. Each tab sheet contains a

MAX5387 Evaluation System

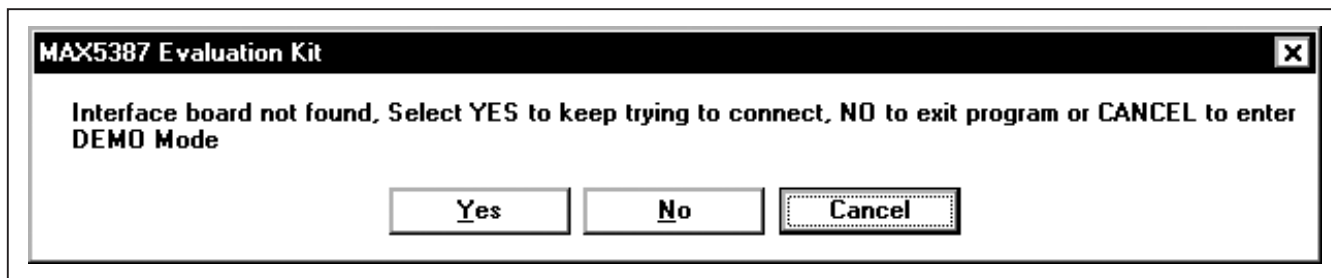

Figure 2. MAX5387 Evaluation Kit Popup Window (Interface Board Not Found)

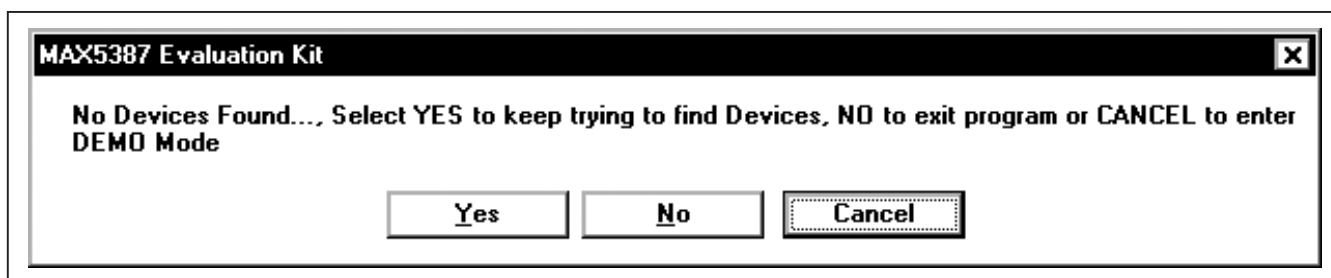

Figure 3. MAX5387 Evaluation Kit Popup Window (No Devices Found)

Device Address combo box to select a valid address and a status indicator to indicate which device is connected. An **Update Pot A and B** checkbox is available for updating both potentiometers A and B simultaneously. A **Default** button resets the respective IC's potentiometer A and B wiper positions to the factory-default midscale position.

Device Address

Each tab sheet contains a **Device Address** combo box and a **U_ Status** indicator. The **U1_MAX5387** and **U3_MAX5392 Device Address** combo boxes store up to eight device addresses found by the EV kit software. The eight possible addresses are shown in Table 4. Use the **Device Address** combo box to select between different devices that share the same bus. Before selecting U1 and U3 addresses, verify jumpers JU7, JU8, JU9 (U1) and JU15, JU16, and JU17 (U3) settings and then select the correct addresses using the **U1_MAX5387** and **U3_MAX5392** tab sheets' **Device Address** combo boxes. **U2_MAX5387** and **U4_MAX5392 Device Address** combo boxes store addresses 0x52 and 0x5A, respectively.

The **U_ Status** indicator displays **Device Connected** when the selected address is found or **No Connection** when the selected address is not found. When selecting an address currently in use, the **Device Address** combo box is set to **??** and the **U_ Status** indicator displays **No Connection**.

Factory Default

Pressing the **Default** button resets potentiometer A and B wiper positions to the factory-default midscale position.

Potentiometer A and B Wiper Positions

The wiper position track bars (WA and WB) in the **Potentiometer A** and **Potentiometer B** group boxes are used to change the wiper position between the H_ and L_ end points. Use the computer mouse or arrow keys to move the wiper position between the 256 position points. The wiper position can also be changed by entering the desired integer value in the edit boxes, or by pressing the up or down arrows in the respective edit box. A change in the **W_ wiper position** track bars, or **HW_/WL_** edit boxes, writes to the volatile memory and the wiper position is updated with the data sent. The wiper position is shown in the **HW_** and **WL_** edit boxes. The **HW_** edit box shows the wiper position with respect to the H_ end point and the **WL_** edit box shows the wiper position with respect to the potentiometer L_ end point.

Potentiometers A and B can be updated simultaneously by checking the **Update Pot A and B** checkbox. When enabled, the **Potentiometer A** group box sends the same data to both digital potentiometers using the 0x13 command to control both digital potentiometers together.

Command Sent Indicator

The **U_ Command Sent** indicators in the **DEVICES** group box display the last command sent from the master (software) to the MAX5387. There are three MAX5387 commands available in the MAX5387 IC. Table 2 describes the three MAX5387 commands.

MAX5387 Evaluation System

Table 2. MAX5387 I²C Commands

MAX5387 REGISTER	COMMAND		DESCRIPTION
	BINARY	HEX	
VREGA	00010001	0x11	I ² C data is written to potentiometer A. Wiper WA position updates with I ² C data.
VREGB	00010010	0x12	I ² C data is written to potentiometer B. Wiper WB position updates with I ² C data.
VREGAB	00010011	0x13	I ² C data is written to potentiometers A and B. Wipers WA and WB position updates with I ² C data.

Data Sent Indicator

The **U_ Data Sent** indicators in the **DEVICES** group box display the last data sent from the master (software) to the MAX5387. The **U_ Data Sent** indicators display the last data sent for the write to potentiometer A (0x11), potentiometer B (0x12), or both potentiometer (0x13) commands.

The MAX5387 IC uses an 8-bit (MSBs, D7–D0) data byte to set the wiper position. Refer to the MAX5387 IC data sheet for additional information.

Keyboard Navigation

Press the Tab key to select each GUI control. The selected control is indicated by a dotted outline. Using Shift + Tab moves the selection to the previously selected control. Buttons respond to the keyboard's space bar and some controls respond to the keyboard's up and down arrow keys. Activate the program's menu bar by pressing the F10 key and then press the letter of the desired menu item. Most menu items have one letter underlined, indicating their shortcut key.

When a number is entered into the edit boxes, it can be sent to the device by pressing the Enter key. It is also sent when Tab or Shift + Tab is pressed.

Simple I²C Commands

There are two methods for communicating with the MAX5387 EV kit, through the normal user-interface panel (Figure 1) or through the I²C commands available by using low-level SMBus commands, or by selecting the **2-Wire Interface** (Figure 4) utility from the **Options | Advanced User Interface** menu bar. A window is displayed that allows I²C operations, such as **SMBusReadByte** and **SMBusWriteByte**. Do not use the **SMBusReadByte** operation because the MAX5387 does not send data to the master.

Note: The I²C dialog boxes accept numeric data in binary, decimal, or hexadecimal. Hexadecimal numbers

must be prefixed by \$ or 0x. Binary numbers must be exactly eight binary digits. See Figure 4 for an example of this tool. In this example, the software is writing data 0xFF to the register address 0x13 to the device with the device address 0x52. The data sequence sets the MAX5387 (U2) wiper positions WA and WB to 255.

Refer to Application Note 476: *Comparing the I²C Bus to the SMBus* available on the Maxim website for information and differences between the SMBus and I²C protocols.

General Troubleshooting

Problem: Software reports it cannot find the interface circuit.

- Is the USB cable connected to the MINIQUSB+ board?
- Has Windows plug-and-play detected the board? Bring up **Control Panel->System->Device Manager**, and look at what device nodes are indicated for USB. If there is an **Unknown device node** attached to the USB, uninstall it—this forces plug-and-play to try again.

Problem: Software reports No Devices Found.

- Is a shunt installed at jumper JU1?
- Are the SCL and SDA signals pulled up to VPOWER (resistors R6, R7, R9, and R10 installed)?
- If using an external power supply, is power applied to the EV kit VDD and GND PCB pads?
- Are shunts installed at jumpers JU7, JU8, and JU9 (set device address)?
- If using an off-board I²C interface, is the power ground connected to the EV kit ground (GND) at one of the header J1 pin connections (J1-2, J1-4 or J1-6)?

MAX5387 Evaluation System

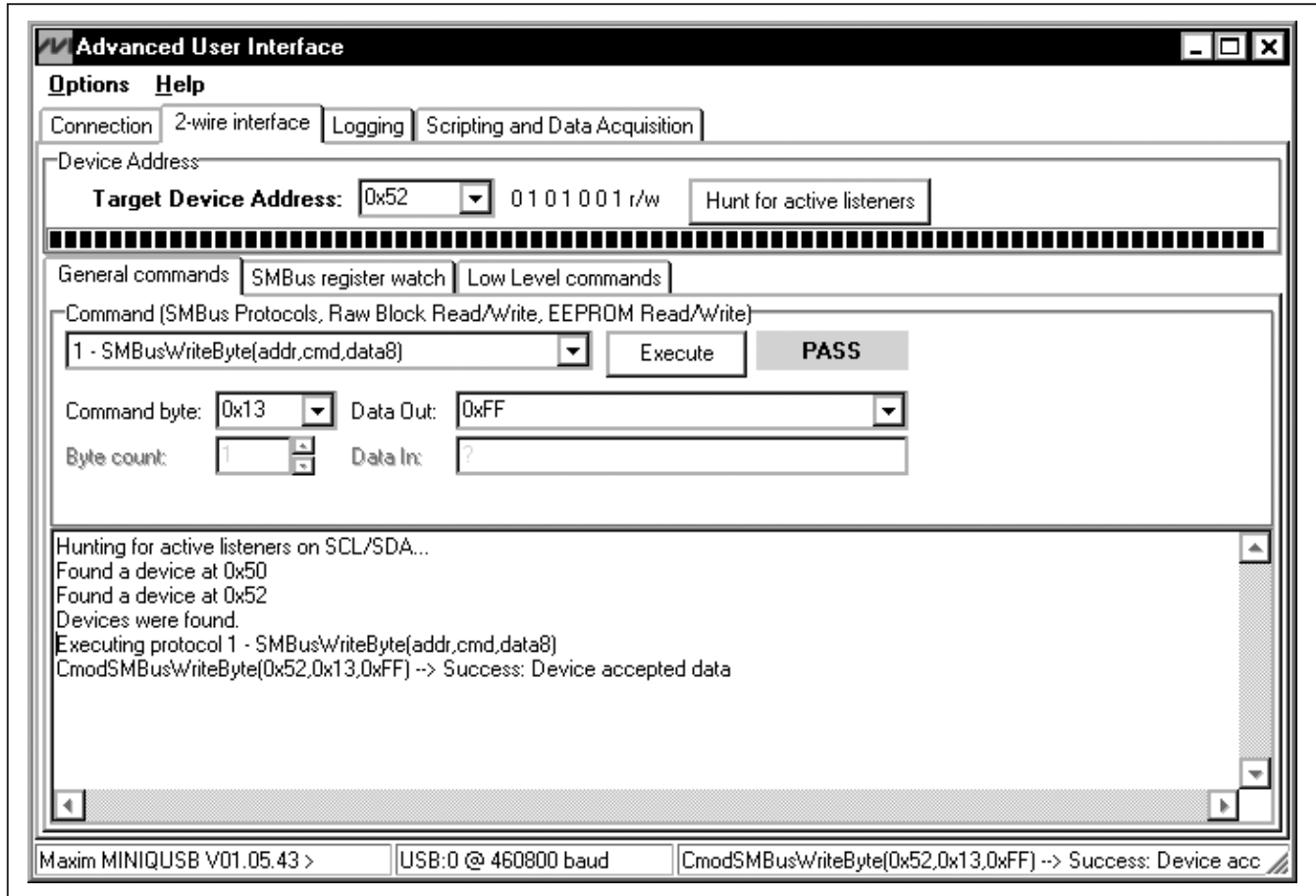

Figure 4. Simple Low-Level 2-Wire Interface

Detailed Description of Hardware

The MAX5387 EV kit is an assembled and tested PCB that features two MAX5387L 10k Ω dual digital potentiometers. The potentiometers have end-to-end resistance of 10k Ω and each wiper can be programmed independently among 256 tap positions. The EV kit includes two MAX5387L ICs (U1, U2) in 14-pin TSSOP packages on a proven two-layer PCB design.

The MAX5387 VDD inputs are powered from the VPOWER rail and are set using jumper JU1. The EV kit provides connector J1 to interface with the MAX5387 SDA, SCLK, and GND signals directly to a user-supplied 2-wire system. Connector J1 also provides a connection for the EV kit VPOWER rail.

The MAX5387 ICs can be powered from a 2.6V, 3.3V, or 5V source generated from the MINIQUSB+ interface board and EV kit circuitry (applied at the EV kit VPOWER

rail), or from a user-supplied external 2.6V to 5.25V DC power supply applied at the VDD and GND PCB pads.

The EV kit is typically used with a MINIQUSB+ interface board for communicating with a PC through the SMBus/I²C serial interface. Logic-level translators U7 and U8 provide proper interface translation when using 2.6V to 5.5V to power the MAX5387 VDD inputs.

The EV kit can also be used to evaluate the MAX5387M and MAX5387N. The EV kit contains PCB footprints for two MAX5392 ICs, which allows the user to independently control up to eight potentiometers. To evaluate the MAX5392, order samples and fit the parts in places U3 and/or U4. Refer to the MAX5392 EV system data sheet for additional information.

MAX5387 (U1, U2) VDD Input Sources

The EV kit features jumper JU1 to select the source for the VPOWER rail of the EV kit circuit. The VPOWER rail is typically supplied as 3.3V or 5V by a MINIQUSB+

MAX5387 Evaluation System

interface board circuitry and 2.6V using LDO regulator U6. The VPOWER rails set both MAX5387 VDD inputs to 5V, 3.3V, or 2.6V. LDO regulator U5 is provided to set the MAX5392 (U3, U4) VDD inputs to 1.7V when evaluating the MAX5392. Refer to the MAX5392 evaluation system data sheet for additional information.

Alternatively, the EV kit VDD and GND PCB pads can be used to supply an external 2.6V to 5.25V to the circuit's VPOWER rail, when evaluating the MAX5387, by removing the shunt at jumper JU1. See Table 3 for proper JU1 configuration for VPOWER when evaluating the MAX5387.

Address Selection for the MAX5387 (U1)

The EV kit circuit feature three jumpers that pull the MAX5387 (U1) A2, A1, and A0 address pins to VDD or GND to set the MAX5387 slave address. See Table 4 for jumpers JU7 (A2), JU8 (A1), and JU9 (A0) settings to set the U1 slave address.

Note: The first 7 bits shown are the address. The Y bit in Table 4 is the I²C read/write bit. The I²C protocol states that this bit is a 1 for a read operation, or a 9 for a write operation. The Y bit is always set to 0 (write only) because these digital potentiometers do not transmit data to the master device.

Table 3. VDD Input Source (JU1)

SHUNT POSITION	VPOWER SOURCE	MAX5387 VDD PINS
1-2	5V (MINIUSB+ circuitry)	5V
1-3	3.3V (MINIUSB+ circuitry)	3.3V
1-4	2.6V (LDO U6)	2.6V
Not installed	External source applied at the EV kit VDD and GND PCB pads	External source applied at the EV kit VDD and GND PCB pads

Table 4. Device Address Selection (JU7, JU8, JU9)

SHUNT POSITION			MAX5387 ADDRESS	
JU7	JU8	JU9	BINARY	HEXADECIMAL
2-3	2-3	2-3	0101 000Y	0x50
2-3	2-3	1-2	0101 001Y	0x52
2-3	1-2	2-3	0101 010Y	0x54
2-3	1-2	1-2	0101 011Y	0x56
1-2	2-3	2-3	0101 100Y	0x58
1-2	2-3	1-2	0101 101Y	0x5A
1-2	1-2	2-3	0101 110Y	0x5C
1-2	1-2	1-2	0101 111Y	0x5E

Note: If component U2 and U4 are installed on the EV kit, the U1 device address should not be set to 0x52 or 0x5A.

I²C Clock and Data Inputs

The MAX5387 features clock and data input pins for I²C-compatible communication to control the MAX5387 wiper position. The clock and data input pins can be driven by the MINIUSB+ interface circuit or the PCB header (J1), along with a user-supplied external I²C-compatible controller. An external I²C-compatible controller can be connected to SDA (J1-3), SCL (J1-5), and GND (J1-2, J1-4, J1-6) on header J1 to communicate with the MAX5387 IC. When using an external I²C-compatible controller, verify that the MINIUSB+ interface board has been disconnected from the EV kit's J2 and J3 headers. See Table 5 for header J1 pin assignments.

The EV kit requires minor alterations when using an external I²C-compatible controller connected at J1:

- 1) Disconnect the MINIUSB+ interface board from the EV kit.
- 2) Remove resistors R6 and R9, which are located at level translators U7 and U8 IO inputs.

Potentiometer, Voltage-Divider or Variable Resistor, with Ground Reference

The EV kit provides an option to configure the MAX5387 as a potentiometer or voltage-divider, open-ended or with ground reference, respectively. Use jumpers JU3

Table 5. Header J1 Pin Assignments

PIN	SIGNAL
J1-1	VDD
J1-2, J1-4, J1-6	GND
J1-3	SDA
J1-5	SCL

MAX5387 Evaluation System

and JU4 for U1 potentiometer A and jumpers JU5 and JU6 for U1 potentiometer B configurations. Tables 6 and 7 list the jumper options for configuring U1 potentiometers A and B. Use jumpers JU18 and JU19 for U2 potentiometer A and jumpers JU20 and JU21 for U2 potentiometer B configurations. Tables 8 and 9 list the jumper options for configuring U2 potentiometers A and B.

The MAX5387 IC can also be configured as a variable resistor by shorting the H_ and W_ pads together using a wire. When operating as a variable resistor, any power source connected to the H_, W_, or L_ pad must be voltage and current limited to the maximum conditions stated in the MAX5387 IC data sheet.

Note: To test the device in resistor mode, the ohmmeter must be GND referenced to the MAX5387. This can be accomplished by connecting the L_ pin to GND or the H_ pin to the MAX5387's VDD input. Resistance can then be measured between W_ and L_ or W_ and H_ PCB pads.

Evaluating the MAX5387M, MAX5387N, and MAX5392 ICs

The EV kit can also evaluate the MAX5387M and MAX5387N. Remove either U1 and/or U2 and replace them with the desired IC.

The EV kit is populated with additional PCB footprints (U3, U4) and various jumpers to evaluate two MAX5392 ICs. See Table 10 for proper jumper configurations when evaluating the MAX5392 IC. Also refer to the MAX5392 EV system data sheet for additional information.

Table 6. JU3 and JU4 Jumper Functions (U1 Potentiometer A)

SHUNT POSITION		HA PAD	LA PAD	MAX5387 FUNCTION
JU3	JU4			
Not installed	Not installed	Not connected	Not connected	Potentiometer open ended
	Installed		Connected to GND	Potentiometer with GND reference
Installed*	Not installed	Connected to VDD	Not connected	Voltage-divider open ended
	Installed*		Connected to GND	Voltage-divider with GND reference

*Default position.

Table 7. JU5 and JU6 Jumper Functions (U1 Potentiometer B)

SHUNT POSITION		HB PAD	LB PAD	MAX5387 FUNCTION
JU5	JU6			
Not installed	Not installed	Not connected	Not connected	Potentiometer open ended
	Installed		Connected to GND	Potentiometer with GND reference
Installed*	Not installed	Connected to VDD	Not connected	Voltage-divider open ended
	Installed*		Connected to GND	Voltage-divider with GND reference

*Default position.

Table 8. JU18 and JU19 Jumper Functions (U2 Potentiometer A)

SHUNT POSITION		HA PAD	LA PAD	MAX5387 FUNCTION
JU18	JU19			
Not installed*	Not installed	Not connected	Not connected	Potentiometer open ended
	Installed		Connected to GND	Potentiometer with GND reference
Installed*	Not installed	Connected to VDD	Not connected	Voltage-divider open ended
	Installed*		Connected to GND	Voltage-divider with GND reference

*Default position.

MAX5387 Evaluation System

Evaluates: MAX5387/MAX5392

Table 9. JU20 and JU21 Jumper Functions (U2 Potentiometer B)

SHUNT POSITION		HB PAD	LB PAD	MAX5387 FUNCTION
JU20	JU21			
Not installed*	Not installed	Not connected	Not connected	Potentiometer open ended
	Installed		Connected to GND	Potentiometer with GND reference
Installed*	Not installed	Connected to VDD	Not connected	Voltage-divider open ended
	Installed*		Connected to GND	Voltage-divider with GND reference

*Default position.

Table 10. Jumper Configuration for MAX5392 Evaluation (JU1–JU26)

JUMPER	SHUNT POSITION	EV KIT FUNCTION
JU1	1-2	VPOWER = 5V
	1-3*	VPOWER = 3.3V
	1-4	VPOWER = 2.6V
JU2	Not installed*	1.7V LDO disabled
	Installed	1.7V LDO enabled
JU3	Not installed	MAX5387 HA disconnected from the U1 VDD voltage source
	Installed*	MAX5387 HA connected to the U1 VDD voltage source
JU4	Not installed	MAX5387 LA disconnected from GND
	Installed*	MAX5387 LA connected to GND
JU5	Not installed	MAX5387 HB disconnected from the U1 VDD voltage source
	Installed*	MAX5387 HB connected to the U1 VDD voltage source
JU6	Not installed	MAX5387 LB disconnected from GND
	Installed*	MAX5387 LB connected to GND
JU7	2-3*	U1 device address = 0x50 (see Table 4)
JU8	2-3*	
JU9	2-3*	
JU10	1-2*	MAX5392 VDD not powered
	2-3	MAX5392 VDD dependent on jumper JU1 configuration
JU11	Not installed	MAX5392 HA disconnected from the U3 VDD voltage source
	Installed*	MAX5392 HA connected to the U3 VDD voltage source
JU12	Not installed	MAX5392 LA disconnected from GND
	Installed*	MAX5392 LA connected to GND
JU13	Not installed	MAX5392 HB disconnected from the U3 VDD voltage source
	Installed*	MAX5392 HB connected to the U3 VDD voltage source
JU14	Not installed	MAX5392 LB disconnected from GND
	Installed*	MAX5392 LB connected to GND
JU15	1-2*	U3 device address = 0x58 (refer to Table 7 in the MAX5392 EV system data sheet)
JU16	2-3*	
JU17	2-3*	
JU18	Not installed	MAX5387 HA disconnected from the U2 VDD voltage source
	Installed*	MAX5387 HA connected to the U2 VDD voltage source
JU19	Not installed	MAX5387 LA disconnected from GND
	Installed*	MAX5387 LA connected to GND

MAX5387 Evaluation System

Evaluates: MAX5387/MAX5392

Table 10. Jumper Configuration for MAX5392 Evaluation (JU1–JU26) (continued)

JUMPER	SHUNT POSITION	EV KIT FUNCTION
JU20	Not installed	MAX5387 HB disconnected from the U2 VDD voltage source
	Installed*	MAX5387 HB connected to U2 VDD voltage source
JU21	Not installed	MAX5387 LB disconnected from GND
	Installed*	MAX5387 LB connected to GND
JU22	1-2*	MAX5392 VDD voltage supplied by the U3 VDD power source
	2-3	MAX5392 VDD voltage dependent on jumper JU1 configuration
JU23	Not installed	MAX5392 HA disconnected from the U4 VDD voltage source
	Installed*	MAX5392 HA connected to the U4 VDD voltage source
JU24	Not installed	MAX5392 LA disconnected from GND
	Installed*	MAX5392 LA connected to GND
JU25	Not installed	MAX5392 HB disconnected from the U4 VDD voltage source
	Installed*	MAX5392 HB connected to the U4 VDD voltage source
JU26	Not installed	MAX5392 LB disconnected from GND
	Installed*	MAX5392 LB connected to GND

*Default position.

MAX5387 Evaluation System

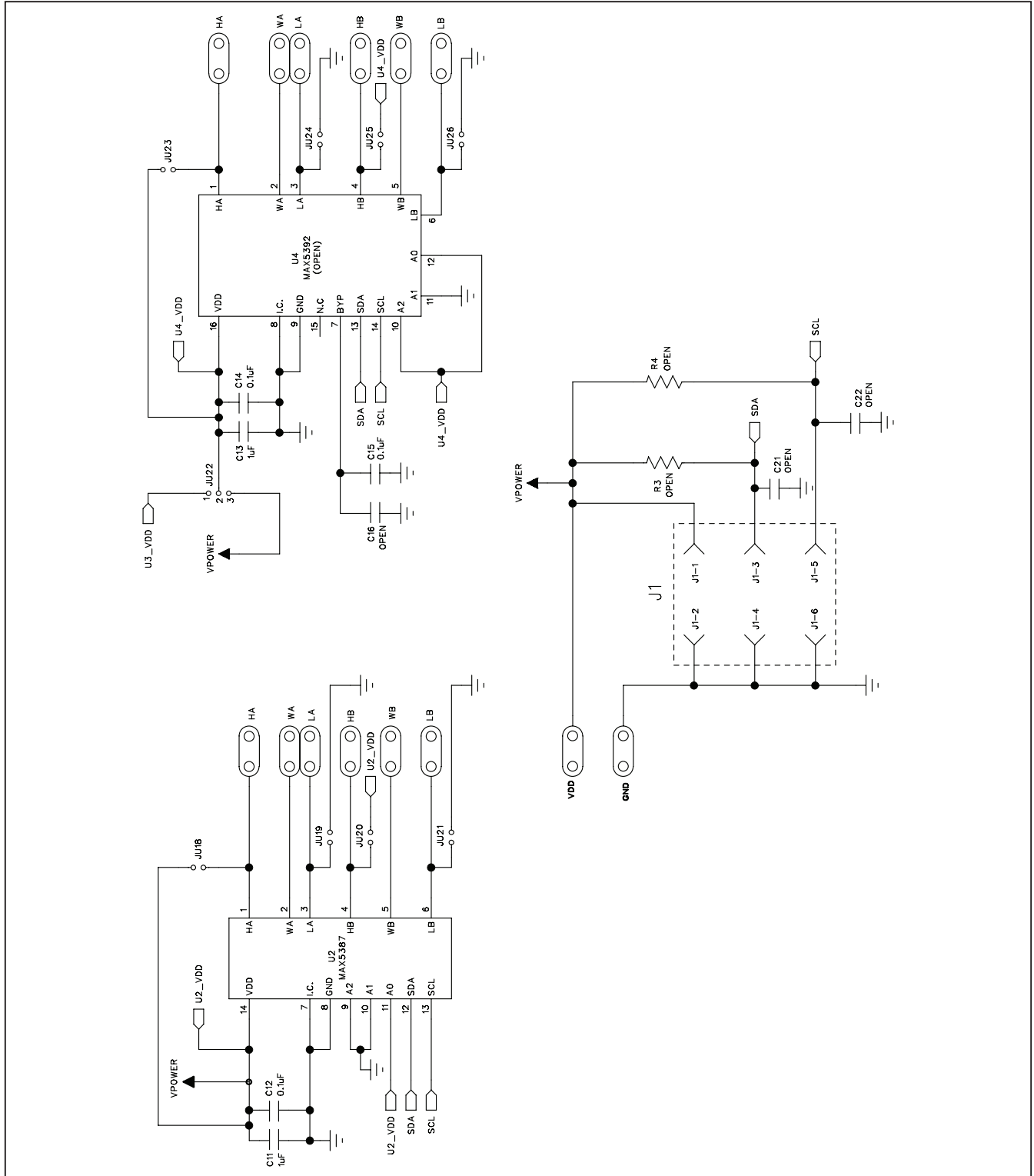

Figure 5b. MAX5387 EV Kit Schematic—Potentiometers U2, U4 (Sheet 2 of 3)

MAX5387 Evaluation System

Evaluates: MAX5387/MAX5392

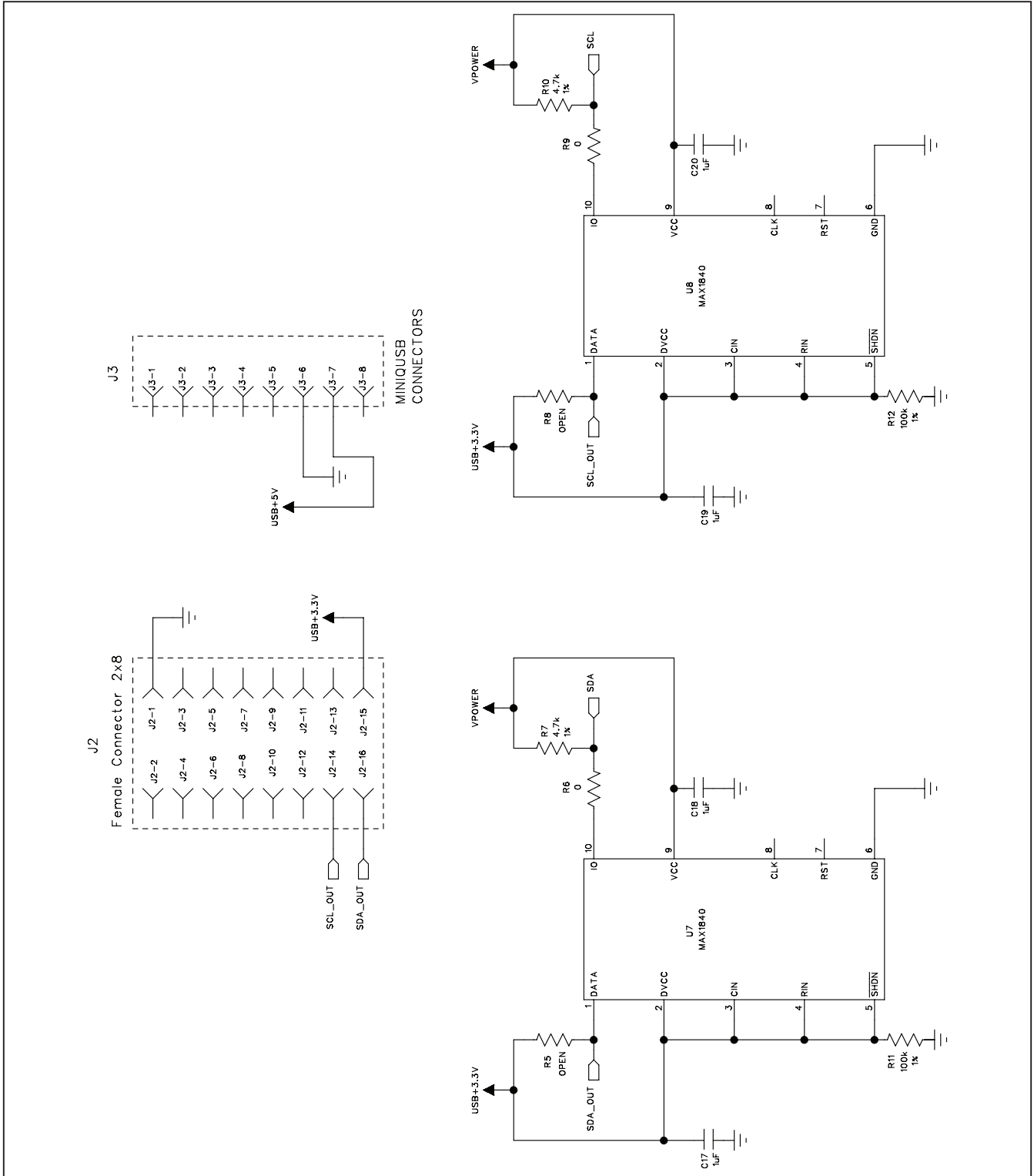

Figure 5c. MAX5387 EV Kit Schematic—Level Translators (Sheet 3 of 3)

MAX5387 Evaluation System

Evaluates: MAX5387/MAX5392

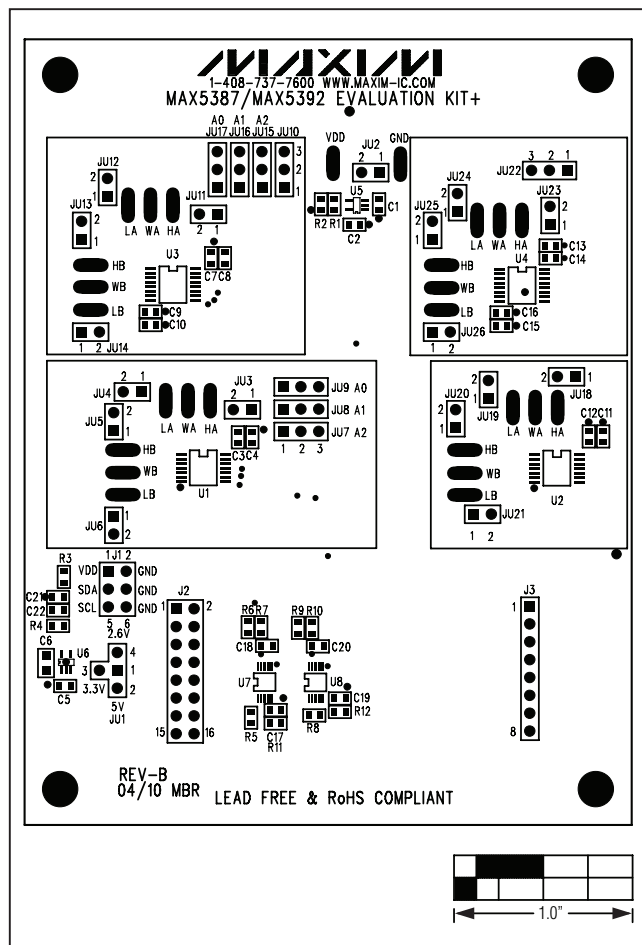

Figure 6. MAX5387 EV Kit Component Placement Guide—Component Side

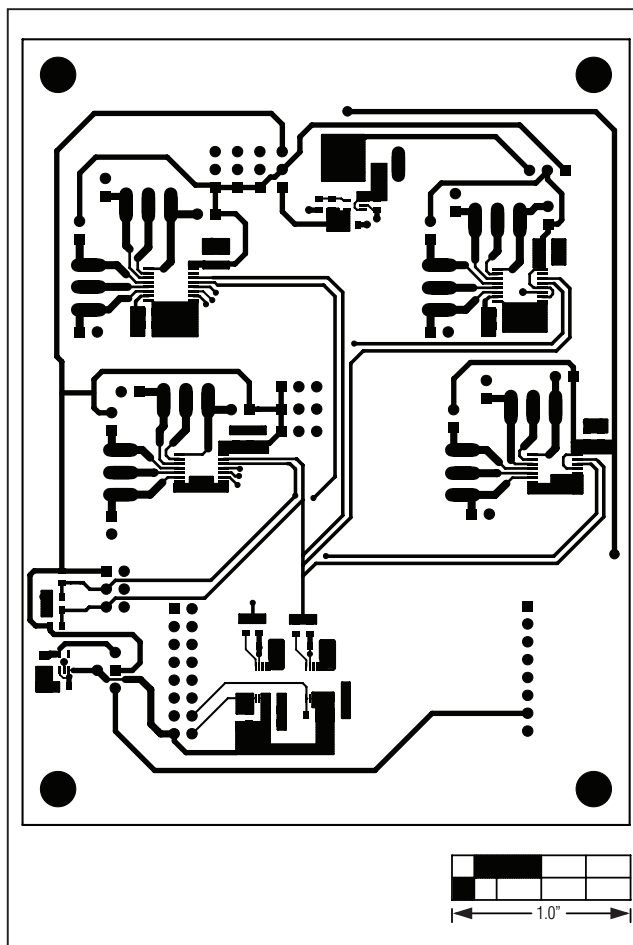

Figure 7. MAX5387 EV Kit PCB Layout—Component Side

MAX5387 Evaluation System

Evaluates: MAX5387/MAX5392

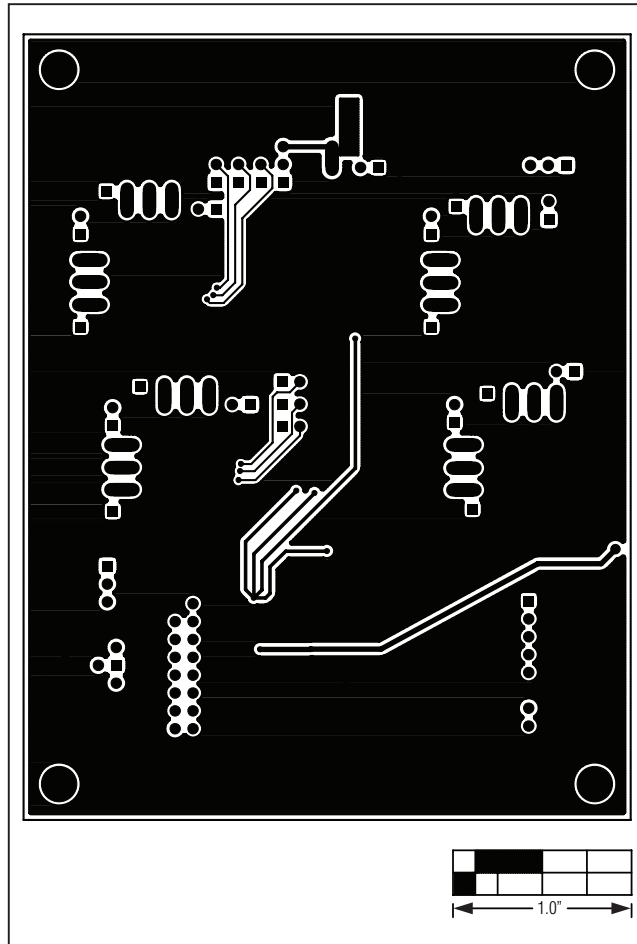

Figure 8. MAX5387 EV Kit PCB Layout—Solder Side

MAX5387 Evaluation System

Evaluates: MAX5387/MAX5392

Revision History

REVISION NUMBER	REVISION DATE	DESCRIPTION	PAGES CHANGED
0	3/10	Initial release	—
1	5/10	Replaced Figures 6 and 7	16

Maxim cannot assume responsibility for use of any circuitry other than circuitry entirely embodied in a Maxim product. No circuit patent licenses are implied. Maxim reserves the right to change the circuitry and specifications without notice at any time.

18 **Maxim Integrated Products, 120 San Gabriel Drive, Sunnyvale, CA 94086 408-737-7600**

© 2010 Maxim Integrated Products

Maxim is a registered trademark of Maxim Integrated Products, Inc.